

## Coplanar a chapa perfil R-1023

### CARACTERÍSTICAS

Sistema Universal

Coplanar altura libre 95mm

Tramos a 0,18m\*

Perfilería y accesorios de Aluminio aleación EN AW 6005A T6 (según Eurocódigo 9)

Fácil montaje

Garantía mínima de 10 años

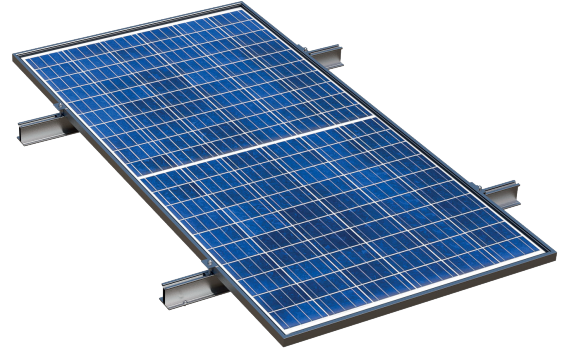

\*Válido para distancias entre greclas de 0,225m. Para otras distancias consultar.



Sistema de fijación a correas

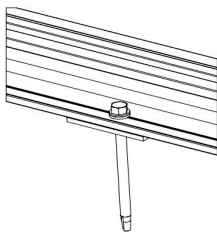

Sistema de fijación a chapa

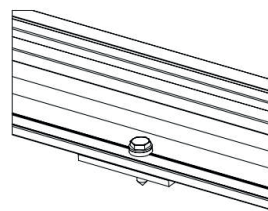

Colación simétrica de tornillos

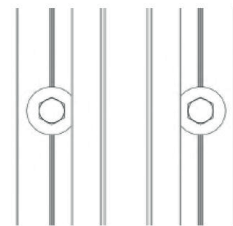

PERFIL R-1023

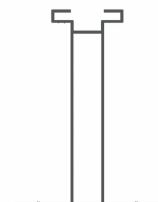

El sistema de estanqueidad está constituido por lámina de caucho EPDM adhesiva de 3mm de espesor ubicada entre la pieza de fijación y la chapa de cubierta. Los tornillos de fijación disponen de arandelas P14 y lámina de caucho para asegurar la estanqueidad.

### HERRAMIENTAS



### SEGURIDAD



Marcado CE  
n° 2375/CPR/21/1014



Se retiene la facultad de realizar cambios. Las imágenes de los productos son ilustrativas y pueden variar respecto al producto final.

mfrenovables@mfrenovables.com

924 290 111

www.mfrenovables.com

C/ Pedregales, nº16 | 06400 - Don Benito (Badajoz)



## Coplanar a chapa perfil R-1023

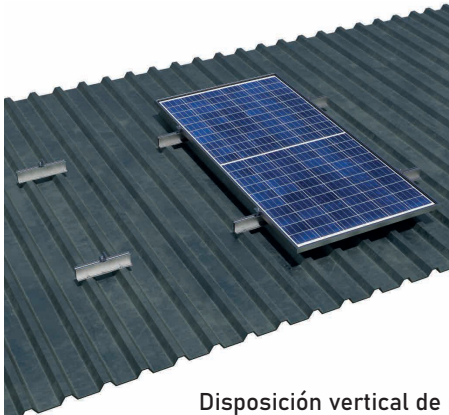

Disposición vertical de módulos



Disposición horizontal de módulos

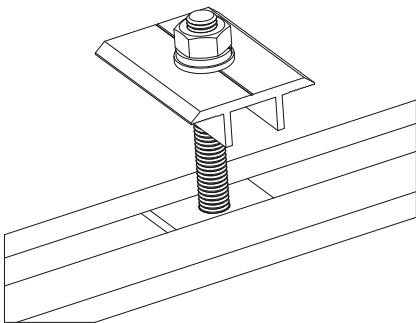

Sistema de fijación intermedia de módulos FV

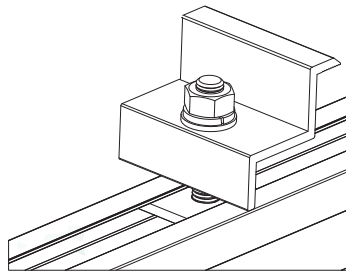

Sistema de fijación final de módulos FV

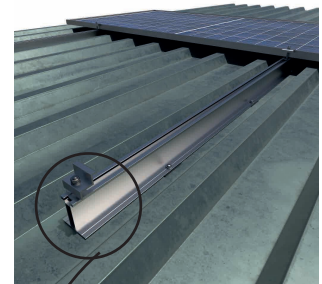

PERFIL R-1023

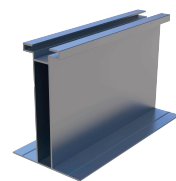

STANDARD CODES	STANDARD TITLES
EN 1990	Eurocode: Basis of structural design
EN 1991-1-4	Eurocode 1: Actions on structures. Part 1-4: General actions- Wind actions
EN 1991-1-3	Eurocode 1: Actions on structures. Part 1-3: Snow loads
EN 1991-1-6	Eurocode 1: Actions on structures. Part 1-6: Actions during execution
EN 1993-1-3	Eurocode 3: Design of steel structures. General rules. Supplementary rules for cold-formed members and sheeting
EN 1993-1-5	Eurocode 3: Design of steel structures. Plated structural elements
EN 1993-1-8	Eurocode 3: Design of steel structures. Design of joints
EN 1993-1-9	Eurocode 3: Design of steel structures. Fatigue
EN 1993-1-10	Eurocode 3: Design of steel structures. Material toughness and through-thickness properties
EN 1993-5	Eurocode 3: Design of steel structures. Piling
EN 1997-1	Eurocode 7: Geotechnical design. General rule
EN 1997-2	Eurocode 7: Geotechnical design. Ground investigation and testing
EN 1998-1	Eurocode 8: Design of structures for earthquake resistance. General rules, seismic actions and rules for buildings
EN 1999-1-1	Eurocode 9: Design of aluminum structures-Part 1-1: General structural rules
EN ISO 14713-1	Zinc coatings- Guidelines and recommendations for the protection against corrosion of iron and steel in structures- Part 1: General principles of design and corrosion resistance
UL 2703	Standard for Mounting Systems, Mounting Devices, Clamping/Retention Devices, and Ground Lugs for Use with Flat-Plate Photovoltaic Modules and Panels
UL 3703	Standard for Solar Trackers
IEC 62727	Photovoltaic systems- Specification for solar trackers
IEC 62817	Photovoltaic systems- Design qualification of solar trackers
ISO 13849	Safety of machinery- Safety related parts of control systems

